

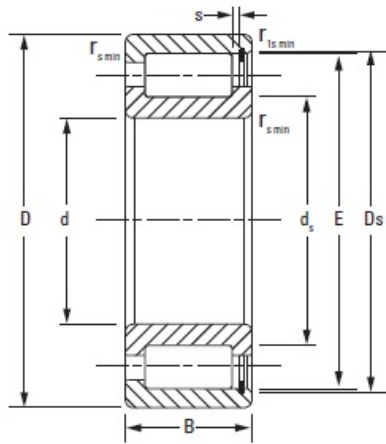

Hebei Xiantong Bearing Co., Ltd.



NCF18/800V Timken Cylindrical Roller Bearing

Bearing No. NCF18/800V

Bore d	800.000 mm
O.D. D	980.000 mm
Width B	82.000 mm
DUR/DOR F/E	935.000 mm
Static Load Rating C_0	4930 kN
Dynamic Load Rating C_1^1	2150 kN
Dimension S^2	9.00 mm
Geometry Factor C_g^3	0.3390
Thermal Speed Ratings - Oil	150 rpm
Thermal Speed Ratings - Grease	130 rpm
Weight	231.200 lb
Chamfer r_{smin}	5.00 mm
Chamfer r_{1smin}^4	5.0 mm
Backing Shaft Diameter d_s	845.0 mm
Backing Housing Diameter D_s	937.0 mm

NCF18/800V Bearing 2D drawings and 3D CAD models