

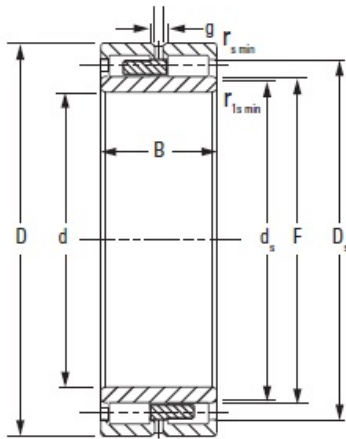

Hebei Xiantong Bearing Co., Ltd.



NNU4144MAW33 Timken Cylindrical Roller Bearing

Bearing No. NNU4144MAW33

Bore d	220 mm
O.D. D	370.000 mm
Width B	150.000 mm
DUR/DOR F/E	258.000 mm
Static Load Rating C_0	2960 kN
Dynamic Load Rating C_1^1	1930 kN
Geometry Factor C_g^2	0.1800
Thermal Speed Ratings - Oil	1000 rpm
Thermal Speed Ratings - Grease	940 rpm
Weight	143.000 lb
Chamfer r_{smin}	4.00 mm
Chamfer r_{1smin}^3	4.0 mm
Backing Shaft Diameter d_s	251.0 mm
Backing Housing Diameter D_s	342.0 mm
Lubrication Groove g	12.3 mm
Lubrication Hole Diameter h	6.0 mm
Number of Lubrication Holes	6
Dimension S^4	5.60 mm

NNU4144MAW33 Bearing 2D drawings and 3D CAD models