

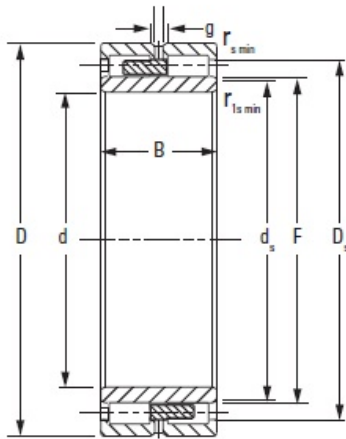

Hebei Xiantong Bearing Co., Ltd.



NNU4148MAW33 Timken Cylindrical Roller Bearing

Bearing No. NNU4148MAW33

Bore d	240 mm
O.D. D	400.000 mm
Width B	160.000 mm
DUR/DOR F/E	282.000 mm
Static Load Rating C_0	3680 kN
Dynamic Load Rating C_1^1	2290 kN
Geometry Factor C_g^2	0.1960
Thermal Speed Ratings - Oil	870 rpm
Thermal Speed Ratings - Grease	800 rpm
Weight	187.400 lb
Chamfer r_{smin}	4.00 mm
Chamfer r_{1smin}^3	4.0 mm
Backing Shaft Diameter d_s	275.0 mm
Backing Housing Diameter D_s	368.0 mm
Lubrication Groove g	12.3 mm
Lubrication Hole Diameter h	6.0 mm
Number of Lubrication Holes	6
Dimension S^4	7.20 mm

NNU4148MAW33 Bearing 2D drawings and 3D CAD models