

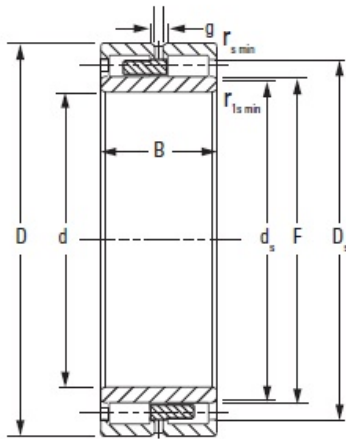

Hebei Xiantong Bearing Co., Ltd.



NNU4968MAW33 Timken Cylindrical Roller Bearing

Bearing No. NNU4968MAW33

Bore d	340.000 mm
O.D. D	460.000 mm
Width B	118.000 mm
DUR/DOR F/E	379.000 mm
Static Load Rating C_0	2660 kN
Dynamic Load Rating C_1^1	1250 kN
Geometry Factor C_g^2	0.2220
Thermal Speed Ratings - Oil	760 rpm
Thermal Speed Ratings - Grease	670 rpm
Weight	123.000 lb
Chamfer r_{smin}	3.00 mm
Chamfer r_{1smin}^3	3.0 mm
Backing Shaft Diameter d_s	380.0 mm
Backing Housing Diameter D_s	487.0 mm
Lubrication Groove g	19.3 mm
Lubrication Hole Diameter h	9.5 mm
Number of Lubrication Holes	8
Dimension S^4	6.30 mm

NNU4968MAW33 Bearing 2D drawings and 3D CAD models